



Datasheet

MOQ Series

Outdoor LED Driver Dimmable

Richmat 豪江

Believe in the Power of Quality

PRODUCT:



FEATURES:

- Efficiency up to 95%
- PF>0.95, THD<10%
- Full power output within recommended operating voltage range
- Constant Current output
- Output current is manually adjustable
- 3 in 1 Dimming Function: 0-10V、PWM、Resistor(Model S), Luminance decrease
- Isolated auxiliary power supply (optional for X version): 12V/0.2A
- Lightning protection level : Difference module 6KV , Common mode 6KV
- IP65 rating for indoor and outdoor
- Protections: BOP、OTP、SCP、OVP-Dimming Interface
- Metal Housing Design with Functional Ground
- Warranty: 5 Years

CERTIFICATIONS:

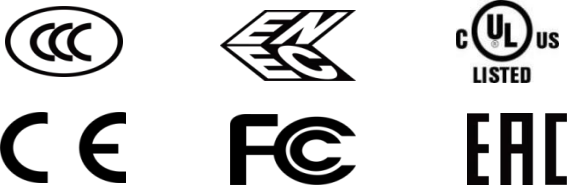

APPLICATIONS:

LED Industrial lighting
LED High Bay Lighting
LED Oil Station Lighting

PRODUCT OVERVIEW:

The HJ-MOQ series is a circular non-isolated constant current drive power supply with rated output powers of 100W and 150W respectively. Applying self-developed patented technology, the driving power supply has superior performance under a wide range of input and output conditions, has high power conversion efficiency, and is a green and energy-saving product. Its adjustable output current and precise dimming control are beneficial to LED lighting design; it has comprehensive active and passive protection functions, which can effectively cope with various harsh working conditions. It has high reliability and low defect rate, which helps reduce the cost of lighting manufacturers.

The HJ-MOQ series has three versions: the A version can only output current through the potentiometer adjustment body, the S version has three-in-one dimming + potentiometer adjustment current, and the X version has three-in-one dimming + potentiometer adjustment current + 12V auxiliary source.

The HJ-MOQ series S version and X version dimming line have three outlet methods: Dimming lines come out from the top, dimming lines come out from the bottom, and dimming lines come out from the top and bottom at the same time (see the product structure diagram for details)

MODULE	Rated input voltage	Rated output power	Output voltage range	Recommended operating voltage	Adjustable range of output current	Power factor	T.H.D	Efficiency	Max Case Temp.
HJ-W100-V266A/S/X-MOQ	120-277V	100W	180-266Vdc	200-266Vdc	0.25-0.5A	0.95	8%	94.5%	90°C
HJ-W150-V266A/S/X-MOQ	120-277V	150W	180-266Vdc	200-266Vdc	0.375-0.75A	0.95	8%	95%	90°C

Remarks: 1. Test conditions of the above parameters: Ta=25C, 230Vac input, full load operation for 30 minutes;

2. The driver can operate normally throughout the entire rated output voltage range, ensuring superior performance of the LED driver within the recommended operating voltage range.

INPUT:

Parameter	Min	Typ.	Max	Note
Rated input voltage	120Vac		277Vac	Applicable to all models
Input voltage range	108Vac		305Vac	Applicable to all models
Input frequency range	47Hz	50/60Hz	63Hz	Applicable to all models
Input current			1.0A	120Vac, full load (HJ-W100-V266A/S/X-MOQ)
			1.5A	120Vac, full load (HJ-W100-V266A/S/X-MOQ)
Input power			120W	120Vac, full load (HJ-W100-V266A/S/X-MOQ)
			170W	120Vac, full load (HJ-W100-V266A/S/X-MOQ)
Input surge current peak value			60A	120Vac, Cold Start
			110A	230Vac, Cold Start
			130A	277Vac, Cold Start
Standby power consumption			1W	230Vac, Full Load
Power factor	0.95	0.97		277Vac, Full Load
	0.9			120-277Vac 50/60Hz, 70-100% Load
Total harmonic distortion		4%	6%	120Vac, Full Load
		8%	10%	230Vac, Full Load
		8%	10%	277Vac, Full Load
			25%	120-277Vac 50/60Hz, 70-100% Load

Remark: All performance parameters are measured at an ambient temperature of 25°C and with the use of LED load, unless otherwise specified.

OUTPUT:

Parameter		Min	Typ.	Max	Note
Output voltage range		180V		266V	Applicable to all models
Rated output voltage		200V		266V	Applicable to all models
Rated output current	HJ-W100-V266A/S/X-MOQ	0.376A		0.5A	At the rated output voltage, the maximum output power $P_o = V_o \cdot I_o = 100W$
	HJ-W150-V266A/S/X-MOQ	0.564A		0.75A	At the rated output voltage, the maximum output power $P_o = V_o \cdot I_o = 150W$
Default factory output current	HJ-W100-V266A/S/X-MOQ		0.5A		
	HJ-W150-V266A/S/X-MOQ		0.75A		
Current adjustment range	HJ-W100-V266A/S/X-MOQ	0.25A		0.5A	
	HJ-W150-V266A/S/X-MOQ	0.375A		0.75A	
Maximum no-load output voltage				330V	Applicable to all models
Efficiency	HJ-W100-V266A/S/X-MOQ		0.915		Input 120Vac, Output 226V/0.376A
			0.945		Input 230Vac, Output 226V/0.376A
			0.945		Input 277Vac, Output 226V/0.376A
	HJ-W150-V266A/S/X-MOQ		0.92		Input 120Vac, Output 226V/0.564A
			0.95		Input 230Vac, Output 226V/0.564A
			0.95		Input 277Vac, Output 226V/0.564A
Current accuracy		-0.05		0.05	100% load constant power range
Output current ripple			0.05	0.1	$\Delta I = I_{pk} - I_{pk} / 2 / I_o \cdot 100\%$
Startup current overshoot				0.1	LED load
Startup time				1000ms	100% load@120-277Vac
Linear regulation rate		-0.03		0.03	100% load
Load regulation rate		-0.03		0.03	100% load
Temperature coefficient		-0.03%/°C		+0.03%/°C	Casing Temp. : 0-90°C
Over temperature protection		90°C		100°C	Casing temperature: Prolonged operation at the highest temperature will reduce the reliability of the power supply. Pay attention to heat dissipation when in use.
Short circuit protection				10W	Not damaged by prolonged short circuits, automatic recovery upon fault resolution.
Input undervoltage protection		96Vac	101Vac	106Vac	Derated output, returns to normal after the abnormal condition is resolved.

Remark: All performance parameters are measured at an ambient temperature of 25°C and with the use of LED load, unless otherwise specified.

DIMMING

Parameter	Description	Min	Typ.	Max	Note
0-10V Dimming	External voltage range	0V		12V	DIM+ output 100uA current
	Recommended dimming voltage	1V		10V	
	Dimming output range	10%		100%	DIM+/DIM-reverse connection prohibited.
	Dimming cutoff voltage	0.30V	0.4V	0.5V	
	Dimming start voltage	0.5V	0.6V	0.7V	
PWM Dimming	PWM High	9.8V		10.2V	DIM+ output 100uA current
	PWM Low	0V		0.3V	DIM+/DIM-reverse connection prohibited.
	PWM Frequency	500Hz		2KHz	
	Recommended dimming duty cycle	10%		100%	
	Dimming output range	10%		100%	
	Dimming cutoff duty cycle	1.5%	2.0%	2.4%	
	Dimming start duty cycle	2.6%	3.0%	4.0%	
Resistor Dimming	External resistor	0Ω		100KΩ	DIM+ output 100uA current
	Dimming output range	10%		100.0%	
	Dimming cutoff resistance	3.0KΩ	4.0KΩ	5.0KΩ	
	Dimming start resistance	5KΩ	6.0KΩ	7KΩ	
Interface protection	Interface over voltage protection			400Vdc or 277Vac	Interface not damaged within 30 minutes.
Auxiliary power supply (optional for X version)	Rated output voltage	11.4V	12V	12.6V	
	Rated output current			200mA	

Remarks:

1. The dimming interface can withstand voltages within 277Vac for a short period of time (within 30 minutes) without damage, and returns to normal after the fault is resolved; when the dimming interface is connected to AC mains power, the output current drops to half of the set current value. Construction workers can quickly identify and resolve faults based on this phenomenon to avoid permanent damage to the interface;

2. All performance parameters are typical values measured at an ambient temperature of 25°C and using an LED load, unless otherwise specified;
3. When the dimming line is not in use, please seal the dimming line connector with an insulating sleeve to prevent interference signals from causing damage to the dimming line and affecting the normal operation of the power supply;
4. The auxiliary power supply function is only applicable to the X version series;
5. Instructions for dimming without afterglow:

When the dimming signal is 0V, the power supply has no output, but there will be junction capacitance between the copper foil of the aluminum substrate and the ground wire, causing the lamp beads to appear slightly bright. It is recommended that each lamp bead be paralleled in a 1206 package of 3-5KΩ. resistor, the parallel connection method is as follows:

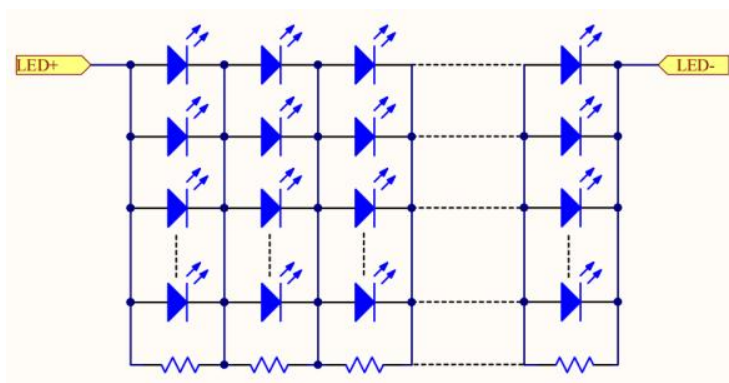

OTHER:

Parameter	Description	Note
Estimation of Mean Time Between Failures (MTBF)	100W/150W:260,000 hours	230Vac, full load, ambient temperature 25°C (MIL-HDBK-217F).
Lifetime	≥50,000 hours	230Vac, full load, Tc=75°C
International Protection	IP65	Suitable for dry and humid environments, avoid prolonged exposure to rain.
Maximum casing temperature	90°C	
Warranty	5 Years	Casing temperature (Tc point) not exceeding 75°C
Weight	420g (net weight)	HJ-W100-V266A/S/X-MOC
	420g (net weight)	HJ-W150-V266A/S/X-MOC
Dimension	Φ128mm*62.5mm	diameter*height

ENVIRONMENT:

Parameter	Min	Typ.	Max	Note
Operating temperature	-40°C	45°C	90°C	Casing temperature
Operating humidity	10%RH		90%RH	No condensation
Storage temperature	-40°C	25°C	90°C	
Storage humidity	10%RH		90%RH	No condensation

Additional information:

1	The PC cover, shell, plug and other kits used to assemble the power supply in the lamp must meet the fire protection rating of UL94-V0 and above.
2	The product has an external adjustable potentiometer. After adjusting the current, it is recommended to seal the current adjustment hole with 704 silicone and plug the waterproof glue.
3	When the dimming line is not in use, please seal the dimming line connector with an insulating sleeve to prevent interference signals from causing damage to the dimming line and affecting the normal operation of the power supply.
4	The withstand voltage of LED lamp beads and aluminum substrate must be >3KV.
5	Aluminum substrate wiring safety regulations creepage distance >5mm.
6	The creepage distance between LED+ and LED- on the aluminum substrate is >1.8mm.
7	Minimize the copper laying area on the aluminum substrate to reduce junction capacitance and leakage current.
8	It is recommended to arrange the LED lamp beads in parallel first and then in series.
9	The total output power of the power supply cannot exceed the rated maximum power during use, otherwise the warranty will not be provided.

Safety and EMC:

Items	Standard	Note
CCC	GB 19510.14-2009、GB/T 17743-2021、GB 17625.1-2022	
ENEC	EN 61347-1:2015 EN 61347-2-13:2014 EN 61347-2-13:2014/A1:2017	
CB	IEC 61347-1, IEC 61347-2-13-2016	
CE	EN 61347-2-13:2014 EN61347-1:2008+A1:2011+A2:2013	
UL	UL8750	
Conducted emission	EN 55015/GB 17743	Conducted emission Test & Radiated emission Test
Radiated emission	FCC Part 15 Subpart B	
Harmonics Current	EN 61000-3-2	Harmonic current emissions
Voltage flicker	EN 61000-3-3	Voltage Fluctuations & Flicker
ESD	EN 61000-4-2	Electrostatic Discharge (ESD): 8 kV air discharge, 4 kV contact discharge
Radiated Susceptibility	EN 61000-4-3	Radio-Frequency Electromagnetic Field Susceptibility Test-RS
Surge (transient)	EN 61000-4-5	Surge Immunity Test: Differential Mode 6 kV, Common Mode 6 kV
Conducted immunity	EN 61000-4-6	Conducted Radio Frequency Disturbances Test-CS
Power frequency magnetic field	EN 61000-4-8	Power Frequency Magnetic Field Test
Voltage dips and interruption	EN 61000-4-11	Voltage Dips
Immunity of lighting equipment	EN 61547	Electromagnetic Immunity Requirements Applies To Lighting Equipment
Oscillatory wave immunity	EN 61000-4-12	Oscillatory Waves Immunity Test
Insulation	>10MΩ 500Vdc 输入对调光端	
Dielectric strength	IP-PE=1500Vac IP-DIM=3000Vac OP-DIM=3000Vac DIM-PE=500Vac	
Ground resistance	<0.1Ω, 25A/1min	
Leakage current	<0.75mA 277Vac	

Note: The power supply complies with relevant EMC standards. As part of the terminal equipment system, EMC needs to be reconfirmed in conjunction with the entire system.

Characteristics Curve:

Vin	Peak current	Duration (@10% peak current)	Duration (@50% peak current)
120Vac	56.2A	546us	365us
220Vac	81.3A	552us	372us
277Vac	93.5A	535us	375us

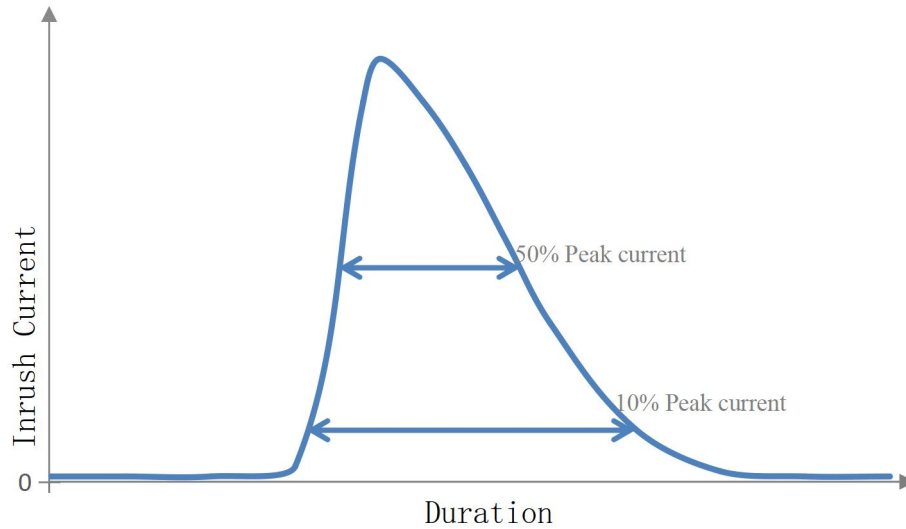

Fig. 1. Inrush Current VS Duration

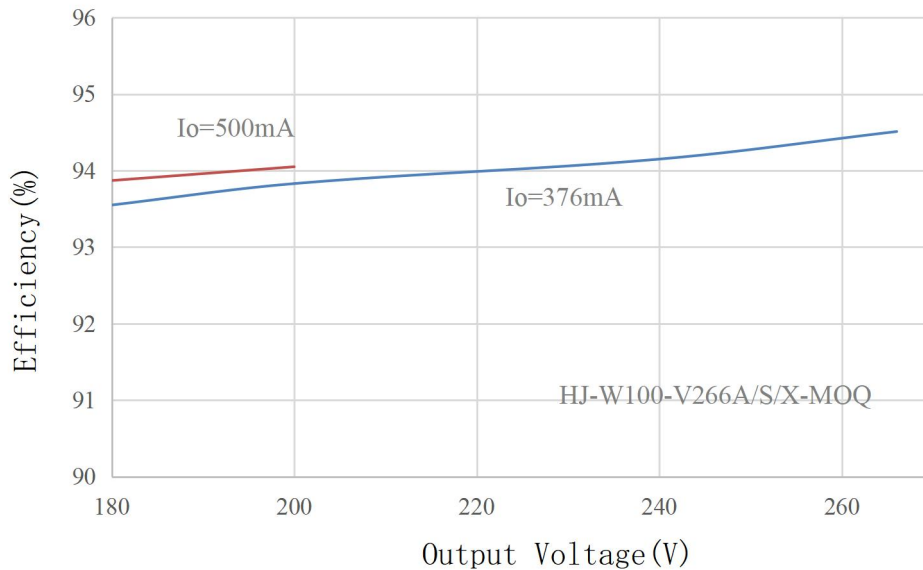

Fig. 2. Efficiency VS Output Voltage

Characteristics Curve:

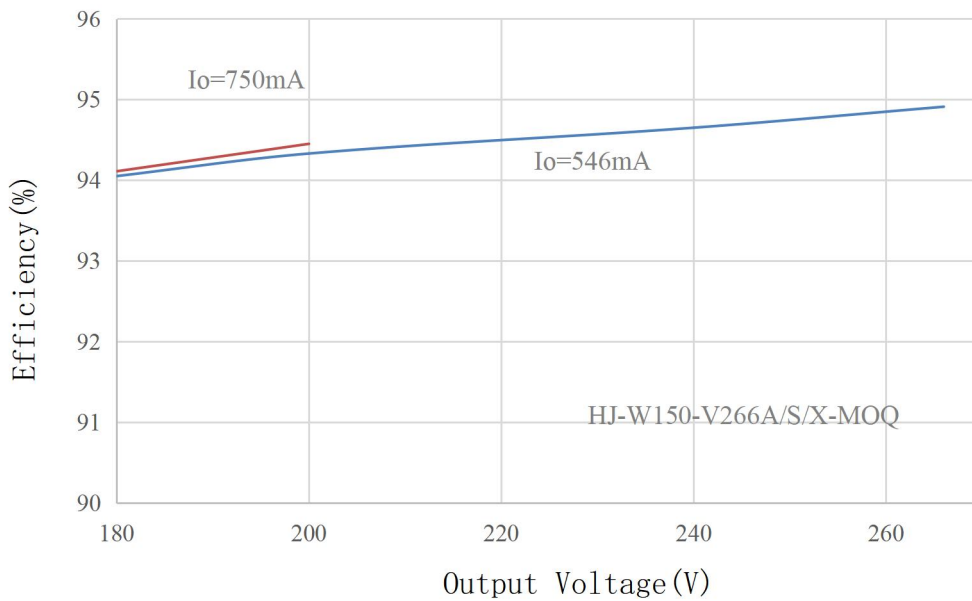

Fig. 3. Efficiency VS Output Voltage

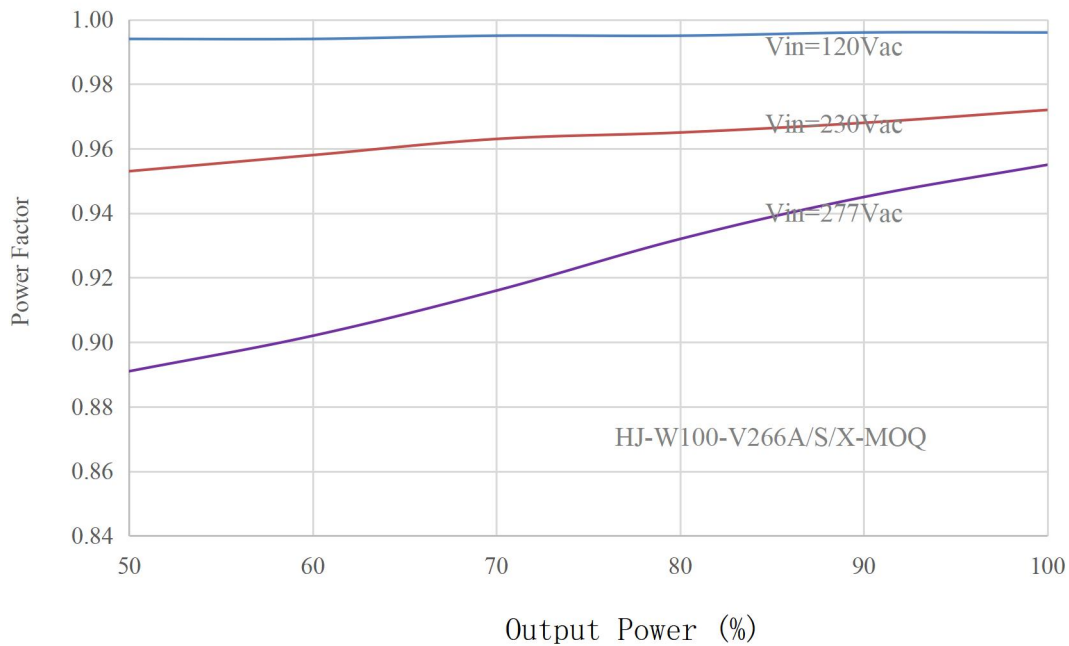

Fig. 4. Power Factor VS Output Power

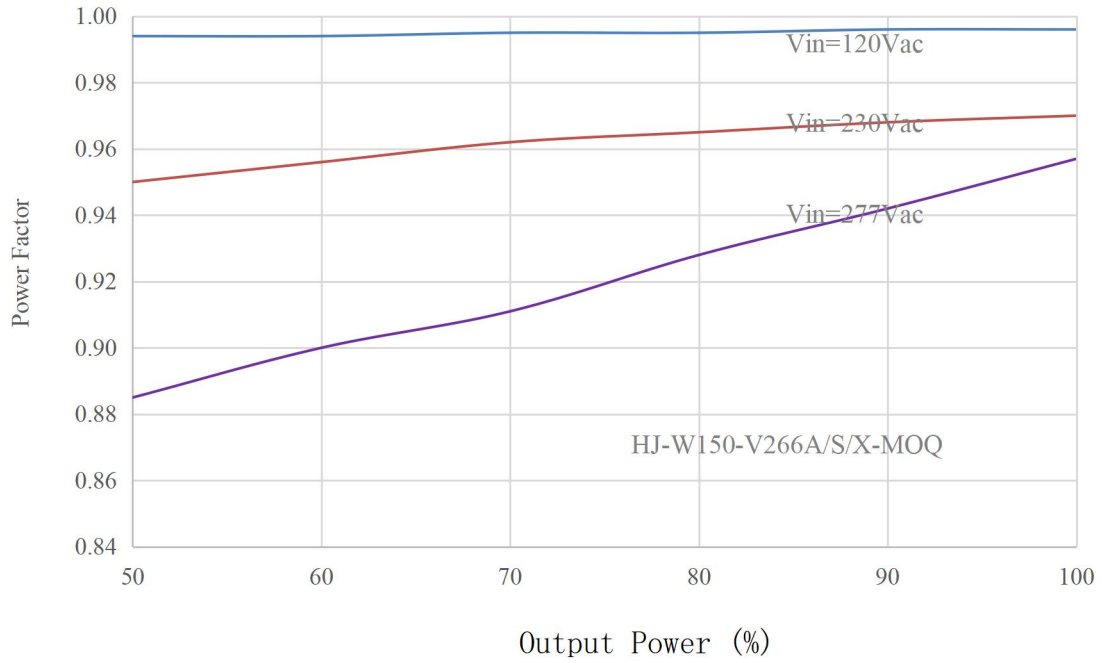

Fig. 5. Power Factor VS Out Power

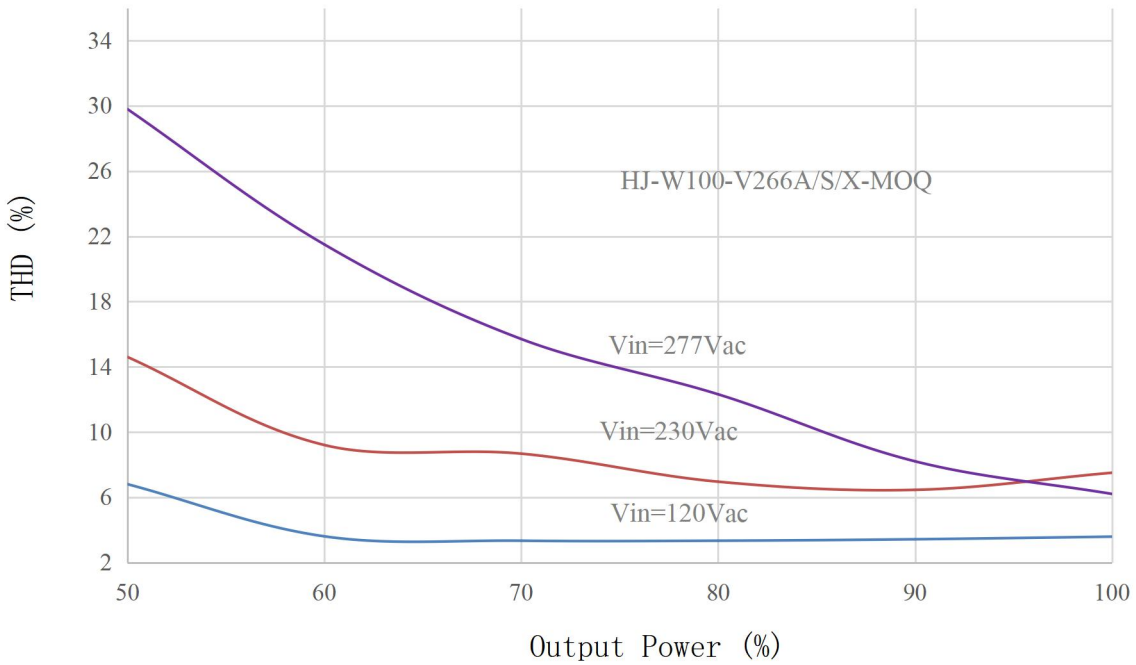

Fig. 6 THD VS Output Power

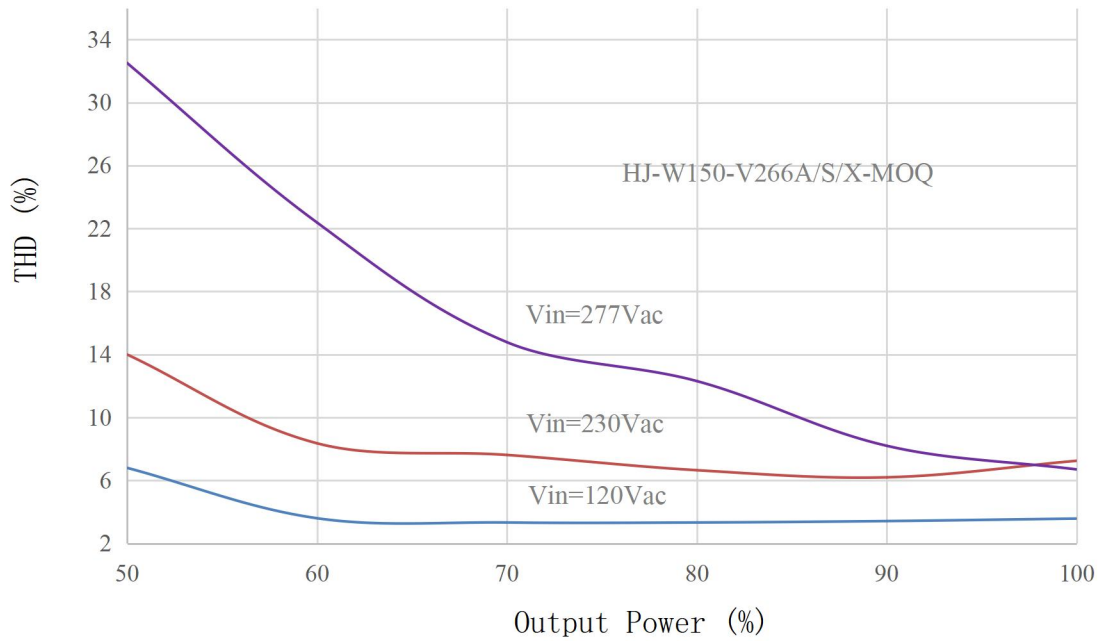

Fig 7. THD VS Output Power

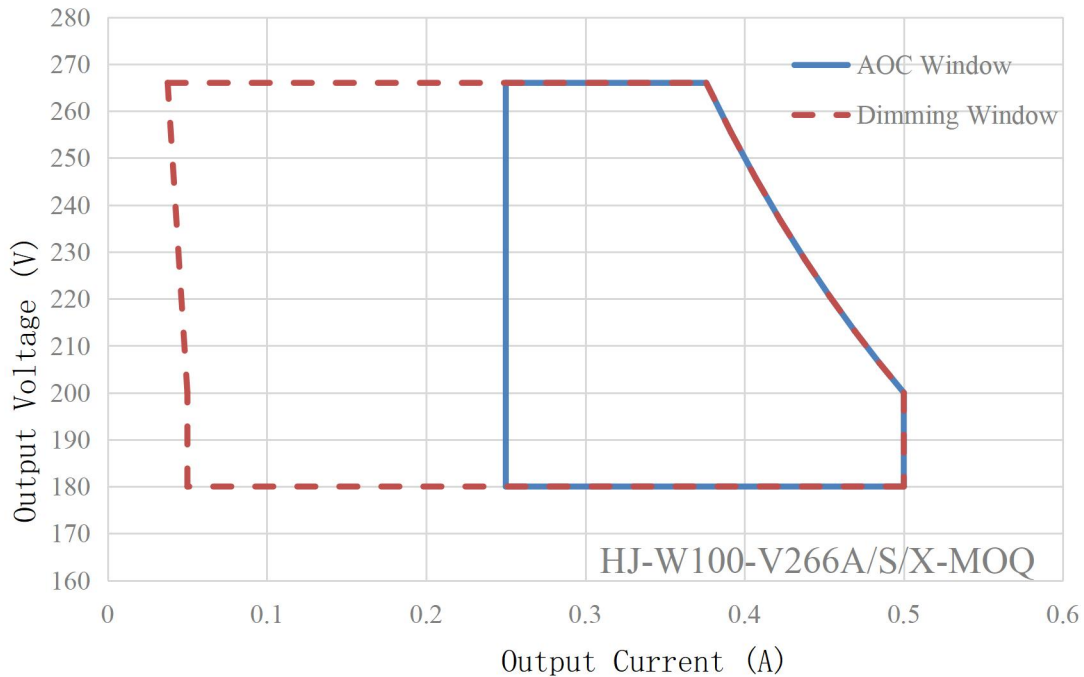

Fig 8. Output Voltage VS Output Current (Dimming/AOC Window)

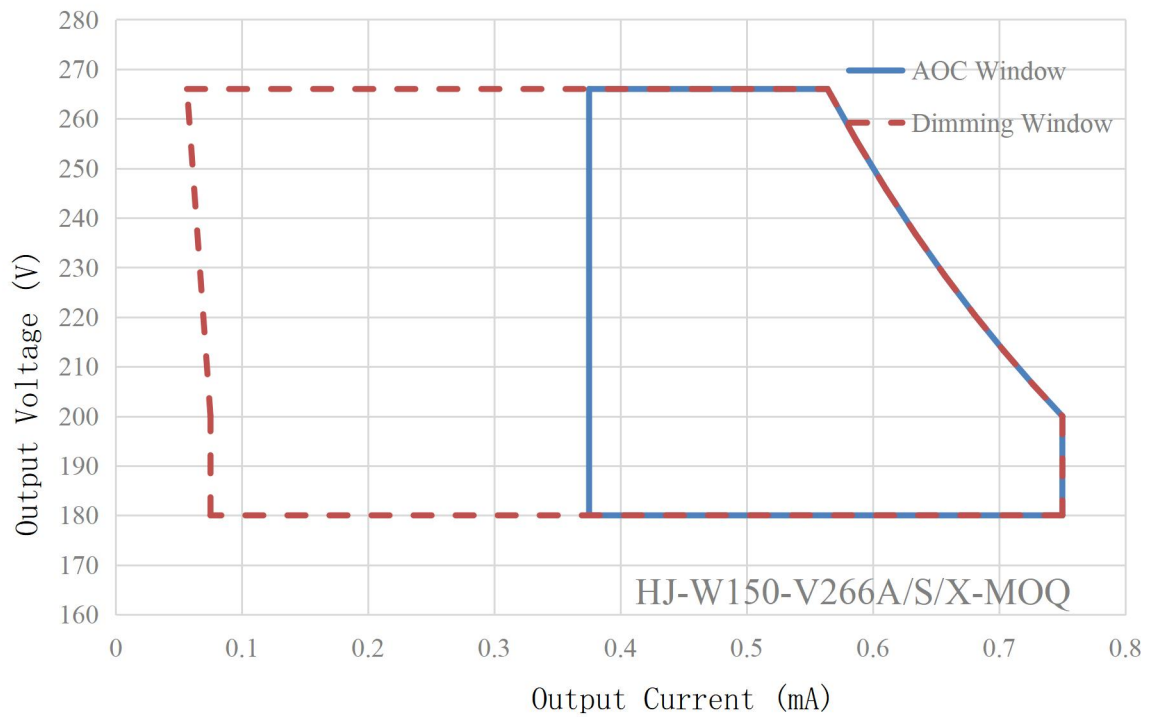

Fig 9. Output Voltage VS Output Current (Dimming/AOC Window)

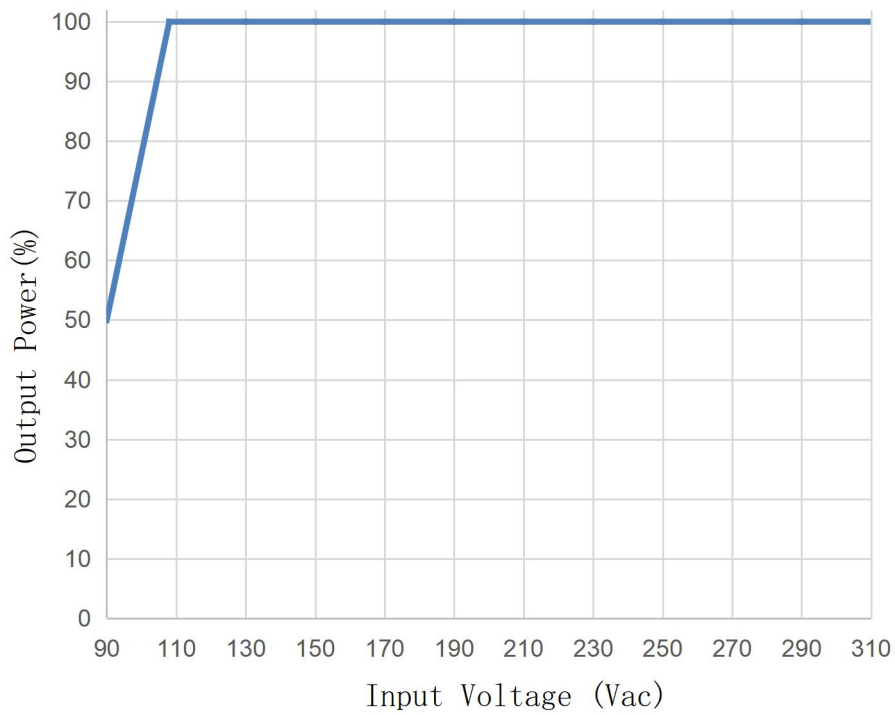

Fig 10. Output Power VS Input Voltage

Voltage (0V-10V) and resistance (0K-100K) dimming

PWM dimming

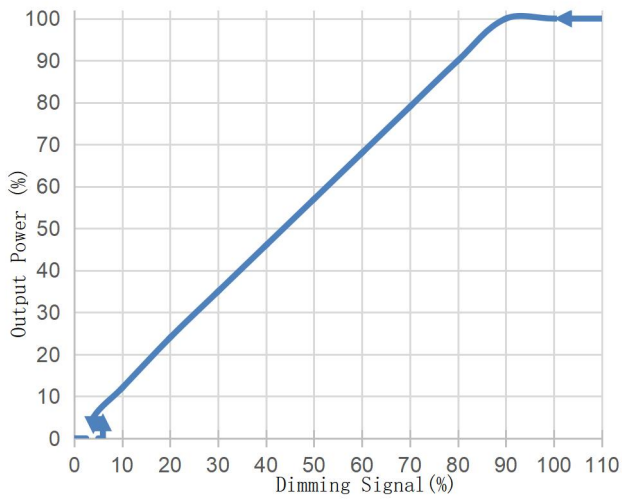

Fig 11. Output Power VS Dimming Signal

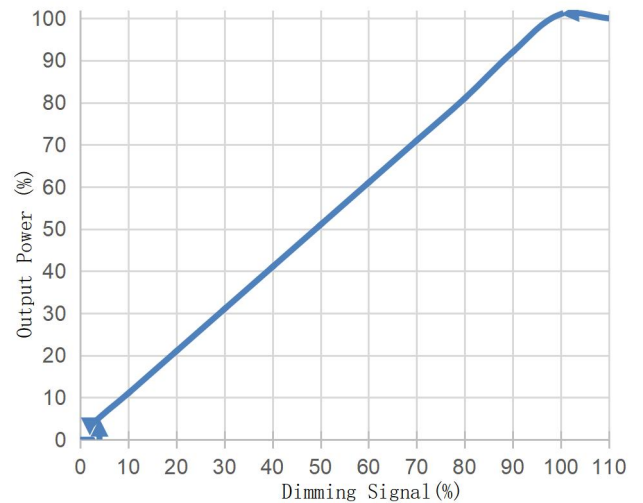

Fig 12. Output Power VS Dimming Signal

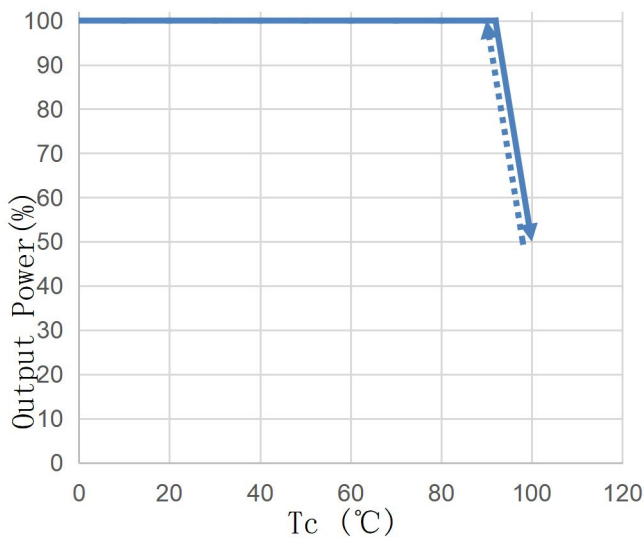

Fig 13. Output Power VS Tc

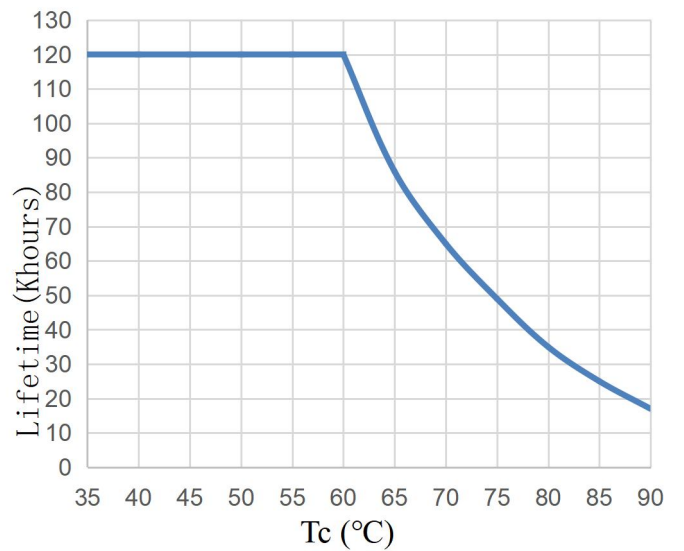



Fig 14. Lifetime VS Tc

Mechanical Specification:

1. wire structure:

AC input line (exposed length 300±10mm): Global: SJOW, 3*17AWG, outer diameter: 8.2mm, brown: ACL, blue: ACN, yellow-green: 

DC output line (exposed length 300±10mm): Global: SJOW, 2*17AWG, outer diameter: 7.8mm, brown: V+, blue: V-

Dimming and auxiliary source cable (exposed length 220±10mm): US/European/Global: UL 2517 3*22AWG, outer diameter: 5.0mm, purple: DIM+, gray DIM-/Vaux-, black/white: Vaux+

Note: The AC input line is stripped to 50mm±5mm and dipped in tin 10mm±1.5mm; the DC output line is stripped 50mm±5mm and dipped in tin 10mm±1.5mm; the dimming and auxiliary power line is stripped 50mm±5mm and dipped in tin 10mm±1.5mm.

2. Appearance dimensions:

Name description	Standard code	Unit (mm)
Shell diameter	D	Φ128
Fixing screw hole diameter	4-B	Φ7
Mounting hole size	W	113
Lifting eye hole	Z	M10*1.5(depth18mm)
Shell height	H	62.5

Structural dimensions:

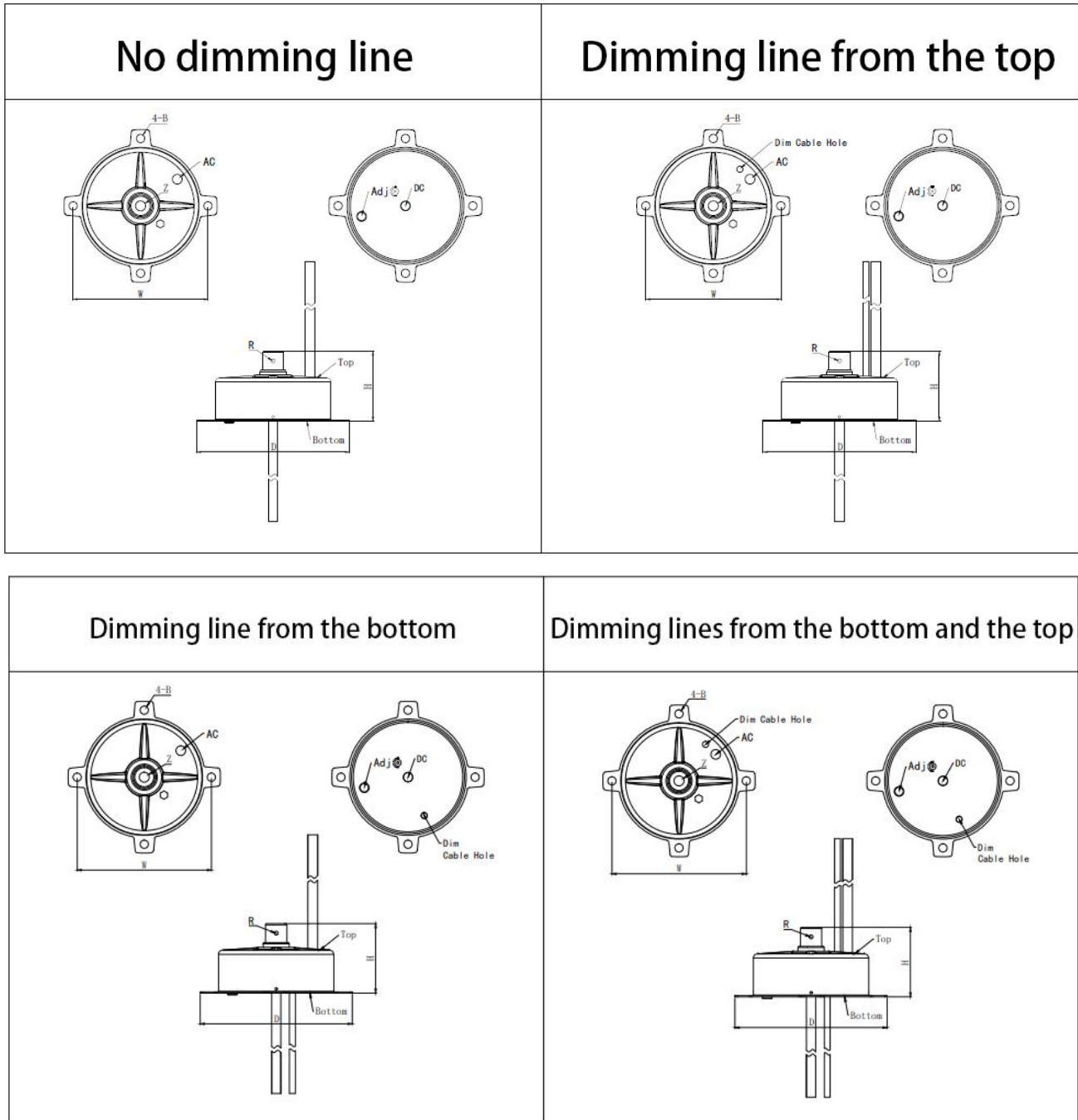

Packaging:

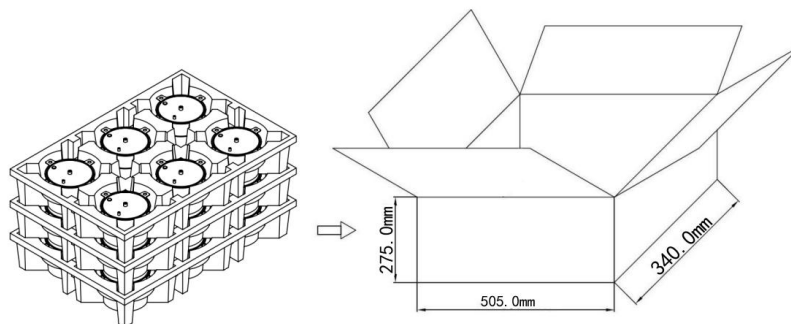

Packaging Description:

Product model	HJ-W100-V266A/S/X-MOQ	HJ-W150-V266A/S/X-MOQ
Net weight each pcs	420g	420g
Gross weight per box	12Kg	12Kg

- The external dimensions of the packaging box (unit: mm) are: Length x Width x Height = 505×340×275;
- Each box contains 18 units, arranged in 3 layers with 6 units per layer.
- The packaging box includes product name, model, manufacturer's identification, quality department's inspection certificate, manufacturing date, and other information.

Shipping:

The packaging is suitable for transportation by car, ship, and airplane. During transport, it should be protected from moisture, sunlight, and handled with care during loading and unloading.

Storage:

Product storage should comply with the provisions of GB 3873-83.

Products stored for more than 1 year should undergo re-inspection, and only after passing the inspection can they be used.

RoHS:

The product complies with the European Union RoHS Directive (2011/65/EU) and the European Parliament Amendment 2015/863/EU.

Update History:

Versions	Description of Update	Update Date	Note
V00	Initial release	2024.01.15	

Edit	Audit	Approval